



**S-10T**  
**S-10TD**  
**S-12T**  
**S-12TD**

---

## **Autosound "S THIN" Series Subwoofer Application & Enclosure Guide**

*Please read through this manual to familiarize yourself with your new speakers. Should your PowerBass Autosound speaker components ever require service, you will need to have the original dated receipt.*



**Thank you and Congratulations**

Congratulations on your decision to purchase PowerBass "S Thin" series woofers. You now own a woofer of uncompromising design and engineering philosophy from a factory that truly believes in the relentless pursuit of perfection. Incorporating the highest quality parts and state-of-the-art materials, these woofers display the ultimate balance between high fidelity, extreme performance and long-lasting reliability.



At Powerbass USA, Inc. we are confident you will have many years of outstanding enjoyment from your superior WOOFER investment. For maximum performance we recommend that you have your new PowerBass "S Thin" series Woofer installed by an Authorized PowerBass Dealer.

To learn more about PowerBass, please visit us on the World Wide Web at  
<http://www.powerbassusa.com>

Δ Warning Δ

Continuous exposure to sound pressure levels in excess of 100 dB can cause permanent hearing loss. PowerBass Autosound Speakers are capable of producing sound pressure levels well over 170 dB. Please observe all local sound ordinances while listening to your PowerBass Autosound system. PowerBass USA, Inc. accepts no liability for hearing loss, bodily injury, or property damage due to the result of use or misuse of this product.

## **POWERBASS AUTOSOUND "S THIN" WOOFER FEATURES**

**Proprietary Composite Polycarbonate / Glass Fiber Basket:** Provides a rigid and stable woofer platform.

**One Piece Injection Molded Cone:** This design ensures low distortion bass reproduction and voice coil alignment.

**Large Roll Rubber Surrounds:** Allows maximum excursion and precision bass reproduction.

**2" Vented KSV Voice Coil Formers:** These specially designed resin coated high temperature voice coils ensure high power handling and precise linear excursion while maximizing thermal heat dissipation.

**Perimeter Aeroventing:** Aeroventing is incorporated in the basket design allowing cooler air to run over the voice coil and keep the motor structure from overheating. Cooler woofers mean better bass!

**Single and Dual 4-ohm Voice Coil:** Made with pure EIW wire for multiple woofer applications and high energy and heat transfer. This makes the voice coil highly efficient, and allows you to play louder for longer.

**Chrome Push Terminals:** These high strength compression loaded speaker terminals ensure maximum current and power transfer.

**Optimally Designed for Small Sealed Enclosures:** For tight area, high SPL applications.

## WIRING GUIDELINES

**It is highly recommended that you seek an authorized PowerBass dealer to properly setup, wire and install your woofers for maximum performance.**

There are multiple ways to wire your woofers depending on your amplifier and system configuration. The use of multiple voice coils offers you more versatility in system configuration. It is important to know the limits of your amplifier to optimize its performance. It is always better to use your subwoofer in a mono / bridged mode if your amplifier has the capabilities. There are basically four different types of wiring configurations: Series, Parallel, Series-Parallel or Parallel-Parallel. It is possible to change the impedance or load by how the speakers are to be wired and by the quantity of woofers used.

### DUAL VOICE COIL WIRING

#### PARALLEL

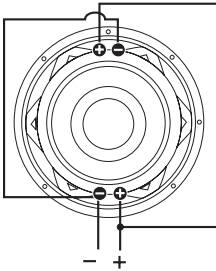

**Amplifier**

Parallel wiring a dual 4 ohm sub = 2 ohm

#### SERIES

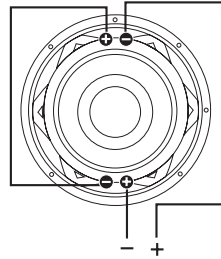

**Amplifier**

Series wiring a dual 4 ohm sub = 8 ohm

#### PARALLEL-PARALLEL

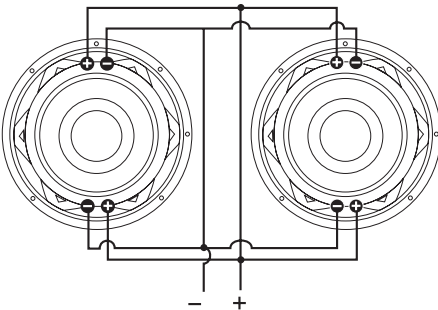

**Amplifier**

Parallel-Parallel wiring two dual 4 ohm subs = 1 ohm

#### SERIES PARALLEL

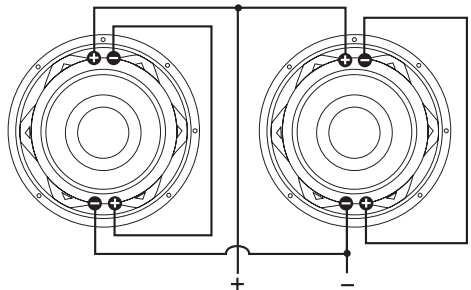

**Amplifier**

Series-Parallel wiring two dual 4 ohm subs = 4 ohm

**NOTE: Never connect only one coil of a Dual Voice Coil (DVC) speaker. BOTH voice coils must be connected to the amplifier**

# SINGLE VOICE COIL WIRING

## STANDARD

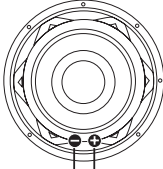

**Amplifier**

Single 4 ohm woofer

## PARALLEL

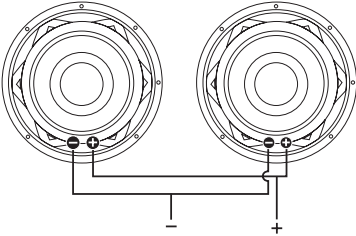

**Amplifier**

Parallel wiring of two single 4 ohm subs = 2 ohms

## SERIES-PARALLEL

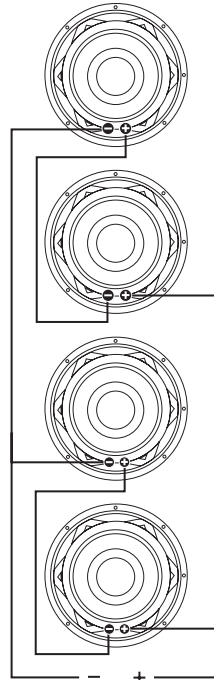

**Amplifier**

Series/ Parallel wiring of four single 4 ohm subs = 4 ohms

## PARALLEL

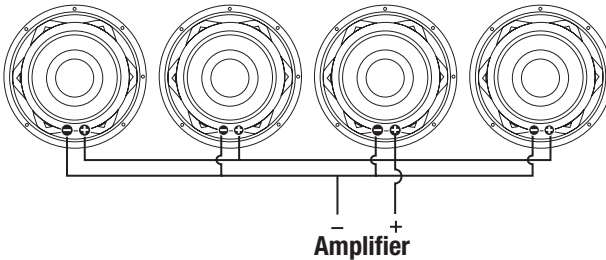

**Amplifier**

Parallel wiring of four single 4 ohm subs = 1 ohms

## INSTALLATION EXPERIENCE

Installation of PowerBass Autosound Subwoofers requires experience with a variety of mechanical procedures including enclosure construction. This manual only provides general installation and operation instructions. If you have any reservations about your installation skills, please contact your local Authorized PowerBass dealer for assistance.

### CHOOSING A SPEAKER ENCLOSURE

The PowerBass Autosound S Thin Subwoofers are engineered to perform at their optimum level in a Sealed enclosure. However, while not optimum, these woofers may also be used in bandpass enclosures. For maximum performance we recommend you have your new PowerBass Autosound Subwoofer installed by an Authorized PowerBass Autosound Dealer.

- **SEALED BOX: (RECOMMENDED)** A sealed or acoustic suspension enclosure is easy to build and typically offers a smaller size enclosure and greater power handling. It has the most predictable frequency and phase response; the bass response will roll off slower than that of a ported design. Sealed boxes typically provide the best musical detail and definition. A well-designed sealed enclosure will exhibit smooth frequency response with excellent sound quality and great low bass extension. They also exhibit relatively accurate, punchy bass reproduction for most types of music. If a sealed enclosure is too large to fit into a specific area of a vehicle, it is possible to decrease the recommended box volume by using 1.5 pounds per cubic feet of low density, high heat specific box stuffing material. PowerBass recommends Fiberglass, Dacron, Poly-Fill or long fiber wool for stuffing the enclosure. ***(Decreasing the box enclosure however should not exceed 20% of the recommended size.)*** When using any type of box stuffing material be sure that the subwoofer's vented pole piece is clear from any obstructions, since covering the pole piece will result in loss of bass and can possibly cause damage to your subwoofer. The most important aspect of a sealed enclosure is to make sure that it is airtight and solid. If your enclosure has any air leaks or if the panels vibrate or flex, you will experience a loss of bass output. Using glue and some type of sealant (caulk) on all seams will ensure a solid constructed box without any air leaks.

- **BANDPASS ENCLOSURE: (NOT OPTIMUM)** The most common band-pass enclosure is a combination of a sealed and a vented enclosure working together (4th order or single reflex band-pass system). The rear of the speaker goes into the sealed chamber while the front of the speaker goes into the vented chamber. Because the vent produces all the sound generated from this type of enclosure, sound quality may not be as good as a well-designed ported or sealed design. Often the sacrifice for sound quality and subwoofer cone control is greater SPL output. However unlike a sealed or vented enclosure, you can effectively increase the enclosure sensitivity with the appropriate tuning choices. You can choose to design a narrow frequency band with very high sensitivity or choose a wide frequency band with the sacrifice of lower sensitivity. The damping effect of the vented chamber reduces the motion of the cone so that potentially higher sound output is achieved without the subwoofer reaching its mechanical limits. Minor deviations from design recommendations however may result in frequency response and distortion problems.

***(If you are intending to use multiple subwoofers in your system, PowerBass recommends having separate chambers for each subwoofer if the subwoofers will be operated by two different amplified signals. This will prevent any possible cancellation.)***

## **TIPS TO GET THE MOST OUT OF YOUR S THIN SERIES WOOFER**

Your PowerBass Autosound subwoofer has been meticulously engineered and designed to handle high power musical reproduction. Despite their rugged construction, it is possible to damage your speaker if they are improperly used. In general, you will hear distortion as a so-called warning before any damage occurs. If you hear distortion in your system, immediately reduce the musical level to the point where the sound retains its clarity.

1. All PowerBass Autosound subwoofers require an initial break-in period before it will reach optimum performance. Like any new precision machinery, allow a minimum of several days to one week with normal daily usage to ensure that the suspension has properly been broken-in.
2. With any dual voice coils subwoofers avoid using only one voice coil. Doing so will significantly decrease the efficiency and power handling of the speaker.
3. Be sure you supply the speakers with enough unclipped amplifier power to drive them properly. (More damage can be done to a speaker by under-powering and clipping your amplifier than any other way!)
4. Where possible, run your Speakers in mono instead of stereo. Most bass is reproduced in mono so there is less chance of any cancellation if played in mono.
5. Where possible, wire your Speakers in parallel instead of series. Bass is reproduced either way but again there is less chance of cancellation in parallel. *NOTE: Be sure the amplifier you are using is stable to the resulting impedance of the speaker load!*
6. Where possible, a separate amplifier just for your subwoofers should be used with an electronic crossover to set the frequency range. One amplifier with passive crossovers will work (Tri-Way Setup), but the system will do more with less stress on the amplifier by using two amps.
7. Do not block the front of your speakers. You want as much direct air coupling as possible.
8. Remember the Golden Rule "Measure twice...cut once."

***Note: The S Thin woofer basket is constructed of composite materials. Please use the enclosed paper template if you are pre-drilling speaker mounting pilot holes--do not use the woofer as a template.***



**BOX CONSTRUCTION:** The material used for enclosure walls should be solid, dense and free of voids or warps. Your enclosure should be made ¾" or 19mm material, Finland or Baltic birch type plywood is recommended where the enclosure will be transported frequently. High-density fiberboard - MDF (not chip board) can be used on permanently installed systems. Minimum of 1" (25mm) or double ¾" (1-1/2") baffle is recommended on high-powered SPL applications. Corners must be strong and air tight and should not have any air leaks or openings. Joints should be properly filled with glue that will not crack under high stress or impact. If the integrity of the glue seal can't be determined, hot glue or RTV caulking should be used to seal all seams. Fiber reinforced resin may also be used to form any difficult shapes. However avoid making large panels with resin to eliminate any chances of box flexing, cracking or ratting under high pressure. Bracing made of 2 x 2" or 2 x 4" should be liberally applied either inside or outside the cabinet, depending on whether the cabinet is to be permanently installed or portable. This principle applies to any walls of the enclosure spanning more than 18" long. Any braces should also be liberally glued or screwed down on edge. Edge-wise drilled, and countersunk holes through the braces can be used for #10-2 Flat-head wood screws to avoid the use of more expensive lag bolts. The majority of strength from an enclosure comes from the glue. When using screws be sure to pre-drill holes to avoid splitting the wood.

***WARNING! The use of silicone rubber to seal in a speaker will void the Warranty! If any sealing is needed in addition to the speaker's gasket, use caulking cord or vinyl weather strip.***

## **SUBWOOFER CROSSOVER SETTING**

Your PowerBass subwoofers will perform best if they are used in conjunction with a subwoofer crossover of some kind. Using a crossover will remove unwanted high frequencies and allow them to concentrate only on bass. The two most common types of crossovers are "passive" or "active" (electronic crossovers are active). Many amplifiers have a built in Low Pass (LPF) electronic crossover circuit. For optimum subwoofer performance we recommend an initial electronic crossover setting between 80-100Hz and then tuning the bass to your liking.

## PREPARING FOR INSTALLTION

***NOTE: The tools listed below may be required for basic installation.***

- An electric drill with bits
- Saber, circular and jig saw
- Phillips-head and standard screwdrivers
- Wire strippers
- Crimping tool and needle-nose pliers
- Silicone sealant (for enclosures), closed cell weather-stripping (for the speakers)

## INSTALLATION PRECAUTIONS

***NOTE: Proceed only if you are a qualified installer otherwise; let your dealer do it.***

- Always wear protective eyewear when using tools.
- Turn off all stereo and other electrical devices before you begin.
- Disconnect the (-) negative lead from your vehicle's battery.
- Keep the speakers in the package until final installation, and always rest it with the cone facing up. Never use force when installing a speaker.
- Locate all fuel lines, brake lines, oil lines, and electrical cables when planning your installation.
- Check to see if there is enough clearance behind the mounting surface before drilling holes or installing screws for proper speaker ventilation.
- Also make sure there's enough front clearance for speaker cone excursion. Failure to do this could cause the cone to vibrate against any obstructing object.
- Use a utility knife to trim away fabric from the speaker mounting hole location before drilling. It is hard to get a good seal if you have both the carpet & subwoofer gasket between the speaker and the enclosure.
- When running speaker wires through sheet metal, be sure to use grommets to properly insulate the wires from metal edges.

## PARAMETERS FOR POWERBASS S THIN SERIES WOOFERS

(Due to Constant Improvements, Specifications and Parameters are subject to change without notice.)

	<b>S-10T</b>	<b>S-10TD</b>	<b>S-12T</b>	<b>S-12TD</b>
<b>VC Impedance (ohms)</b>	4Ω	4Ω + 4Ω	4Ω	4Ω + 4Ω
<b>Test Impedance (ohms)</b>	3.2	6.3 (series)	3.2	6.5 (series)
<b>Driver Displacement</b>	0.0833 cu ft	0.0833 cu ft	0.133 cu ft	0.133 cu ft
<b>Fs (Hz)</b>	40.6	37	34.43	36.43
<b>SD (sqCM)</b>	363	363	530.9	530.9
<b>Vas (Ltr)</b>	18.43	20.86	45.92	41.66
<b>Cms (M/N)</b>	98.49	111.4	114.7	104.1
<b>Mms (g)</b>	156.3	166.4	186.3	183.4
<b>BL™</b>	12.6	16.41	13.04	15.12
<b>Qms</b>	3.494	5.896	3.886	4.464
<b>Qes</b>	0.803	0.93	0.758	1.194
<b>Qts</b>	0.653	0.804	0.634	0.942
<b>No (%)</b>	0.148	0.109	0.238	1.163
<b>Spl (dB)</b>	90	90	91	91
<b>Xmax (mm)</b>	6.8	6.8	6.8	6.8
<b>Voice Coil Size (inches)</b>	2.0	2.0	2.0	2.0
<b>Frequency Response (Hz)</b>	34-400	33-400	31-350	29-350
<b>Motor Structure</b>	116 oz.	116 oz.	140 oz.	140 oz.
<b>Mounting Depth</b>	3.25"	3.25"	3.25"	3.25"
<b>Power (RMS/Peak)</b>	275/550 watts	275/550 watts	300/600 watts	30/600 watts

## RECOMMENDED ENCLOSURES

Please note that these enclosure volume recommendations are for the internal airspace inside the enclosure and include the displacement of the subwoofer and ports. When choosing your enclosure type, please pay close attention to your specific woofer, failing to use the correct enclosure may result in lower power handling and poor sound quality. **To calculate the internal airspace required, take the internal dimensions of the box. First multiple these number by themselves and then divide this sum by 1728. (W x H x D) / 1728.** Please contact your authorized PowerBass Autsound dealer for other designs and specifications. **(Even though these subwoofers can be used in a ported enclosure, PowerBass recommends a sealed enclosure for optimum performance and sound quality.)**

### S-10T

Optimum Sealed Vol.	Standard	Metric
Gross Vb Internal	0.75 cu.ft	21.24Liters
F3 (-3dB Cutoff)	47.93 Hz	47.93 Hz
Poly-Fill	Yes	Yes
Qtc	0.843	0.843
Pe (Watts-Rms)	100-275 Watts	100-275 Watts
Acceptable Volumes	(0.5 - 1.3 cu. ft)	(14.16 - 37.51 Liters)

### S-10TD

Optimum Sealed Vol.	Standard	Metric
Gross Vb Internal	0.75 cu.ft	21.24 Liters
F3 (-3dB Cutoff)	40.34 Hz	40.34 Hz
Poly-Fill	Yes	Yes
Qtc	1.035	1.035
Pe (Watts-Rms)	100-275 Watts	100-275 Watts
Acceptable Volumes	(0.75 - 2.5 cu. ft)	(21.24 - 70.8 Liters)

## S-12T

Optimum Sealed Vol.	Standard	Metric
Gross Vb Internal	1.0 cu.ft	28.32 Liters
F3 (-3dB Cutoff)	44.9 Hz	44.9 Hz
Poly-Fill	Yes	Yes
Qtc	0.952	0.952
Pe (Watts-Rms)	100 - 300 Watts	100 - 300 Watts
Acceptable Volumes	(0.75 - 2.5 cu. ft)	(21.24 - 70.8 Liters)

## S-12TD

Optimum Sealed Vol.	Standard	Metric
Gross Vb Internal	1.0 cu.ft	28.32 Liters
F3 (-3dB Cutoff)	40.9 Hz	40.9 Hz
Poly-Fill	Yes	Yes
Qtc	1.341	1.341
Pe (Watts-Rms)	100 - 300 Watts	100 - 300 Watts
Acceptable Volumes	(1.0 - 3.0 cu. ft)	(28.32 - 84.96 Liters)



## **WE WANT YOU LISTENING FOR A LIFETIME**

Dear Customer,

Selecting fine audio equipment such as the speakers you've just purchased is only the start of your musical enjoyment. Now it's time to consider how you can maximize the fun and excitement your equipment offers. PowerBass and the Consumer Electronics Association (CEA) want you to get the most out of your equipment by playing at a safe level. One that lets the sound come through loud and clear without annoying, blaring or distortion- and, most importantly, without affecting your sensitive hearing.

Sound can be deceiving. Over time your hearing "comfort level" adapts to higher volumes of sound. So what sounds "normal" can actually be loud and harmful to your hearing. Guard against this by setting your equipment at a safe level BEFORE your hearing adapts.

PowerBass and the CEA want you listening for a lifetime!



## POWERBASS AUTOSOUND LIMITED WARRANTY POLICY

PowerBass USA, Inc. offers limited warranty on PowerBass products under normal use on the following terms:

**PowerBass Autosound Speakers are to be free of defects in material and workmanship for a period of one (1) year.**

This warranty applies only to PowerBass products sold to consumers by Authorized PowerBass Dealers in the United States of America. Products purchased by consumers from a PowerBass dealer in another country are covered only by that country's Distributor and not by PowerBass USA.

This warranty covers only the original purchaser of PowerBass product. In order to receive service, the purchaser must provide PowerBass with a valid purchase receipt from an authorized reseller stating the consumer name, dealer, product and date of purchase.

Products found to be defective during the warranty period will be repaired or replaced (with a product deemed to be equivalent) at PowerBass's discretion and will not be liable for incidental or consequential damages. PowerBass will not warranty this product under the following situations:

- **Speakers received with bent frames or water damage**
- **Abuse such as holes in the cone, surround or ripped spider**
- **Voice coil damage due to amplifier clipping or distortion**
- **Product that has not been installed according to this owners manual**

Any implied warranties including warranties of fitness for use and merchantability are limited in duration to the period of the express warranty set forth above. Some states do not allow limitations on the length of an implied warranty, so this limitation may not apply. No person is authorized to assume for PowerBass any other liability in connection with the sale of this product.

**Please call (909) 923-3868 for PowerBass Customer Service.** You must obtain an RA# (Return Authorization Number) to return any product to PowerBass. **The RA number must be prominently marked on the outside of the shipping carton or the delivery will be refused.** Please pack your return carefully; we are not responsible for items damaged in shipping. Return the defective product along with a copy of the original dated retail sales receipt, plus \$12.00 for handling and diagnostic evaluation to:

**PowerBass USA, Inc.,  
Attn: Returns (RA# \_\_\_\_\_ )  
2133 South Green Privado, Ontario, CA 91761**

Residents of HI, AK and US territories will be charged for return shipping. All inquires regarding service and warranty should be sent to the above address.

**Removed or altered serial numbers will void this warranty**



PowerBass Autosound – A division of PowerBass USA, Inc.

2133 South Green Privado – Ontario, CA 91761

Tel. (909) 923-3868 – Fax (909) 923-8048

**[www.powerbassusa.com](http://www.powerbassusa.com)**